

GG 9	8F5K B 6M	7 < 97 ? 98 6M	7 F: BC.	85H9.	89G7 F-DHC B.
U	>K	?6	%' +	&) #\$(#%+	BYk '8Y'U:]h[?]h

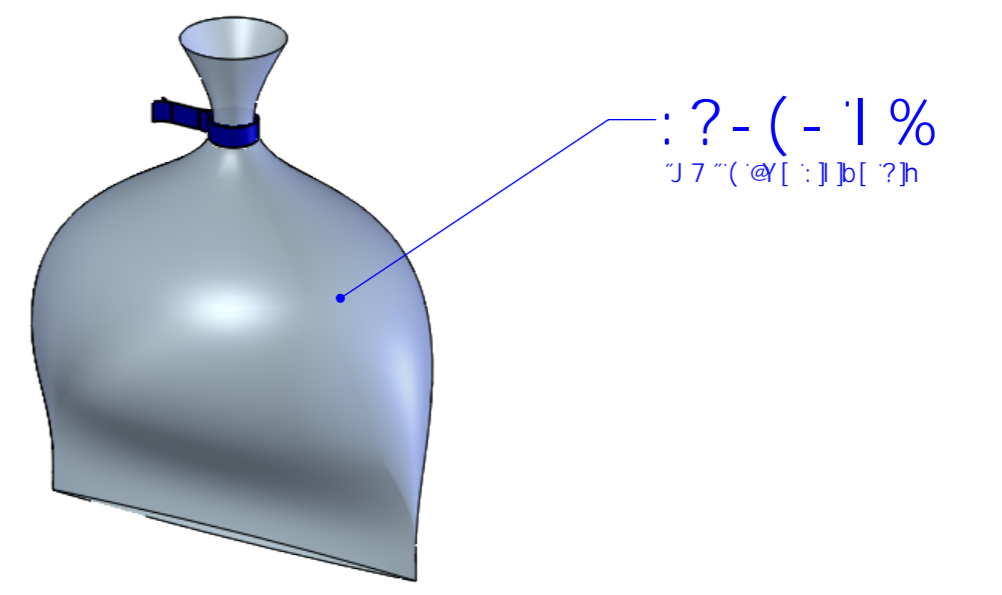

BchYg %" :]h@JVY'ghc '@ [gUgg]ck b'UVcj Y"
 &" : c'X'Df]bhYX 'aJVY'U'cb['YX[Y'cZ?'h6cl "
 ' " Di h'h\fc] [\ \YUhh bbY"

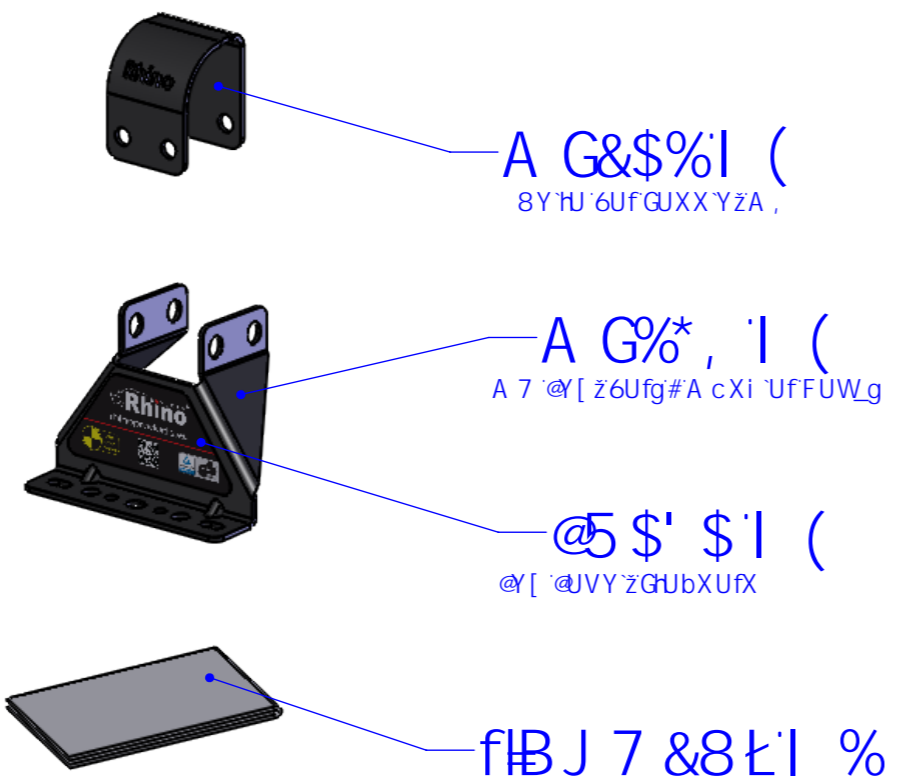
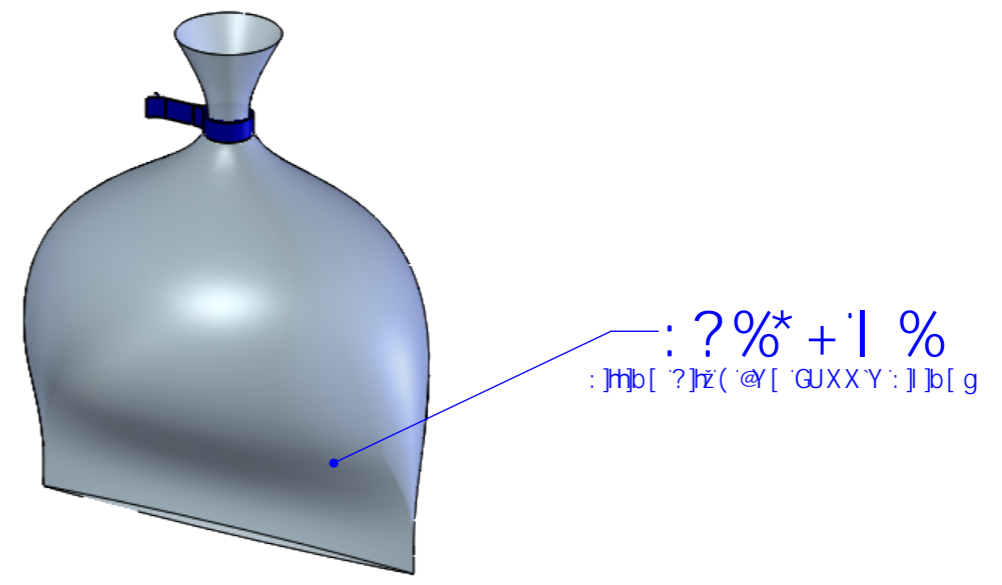
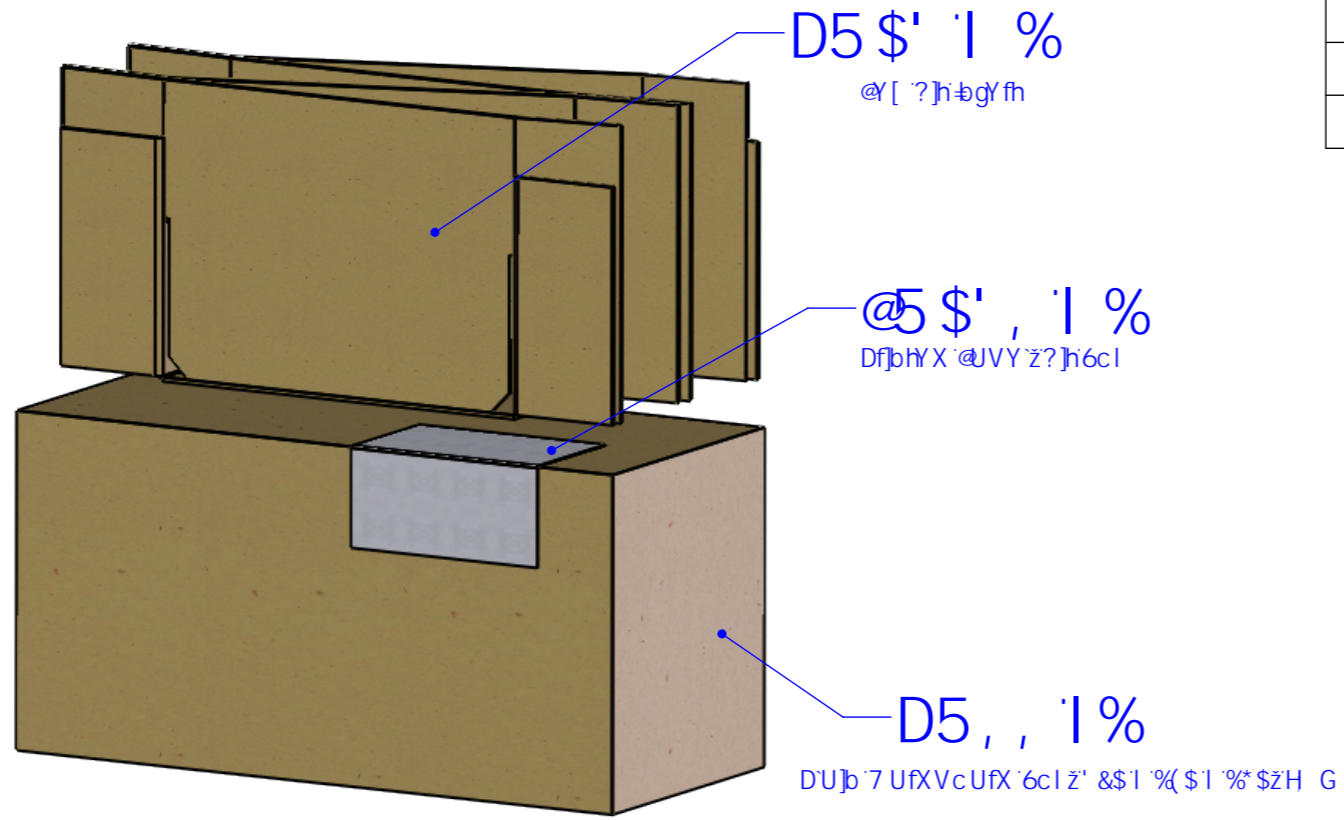

8F5K B: BC. J 7 &8 f]cZ t	89G7 F-DHC B. &'6Uf"J 7 "':]h[?]h8Y'U'6Ufg	89G7 B98 6M >"K]]Ua g &) #\$(#%+
A 5Hf-5@GNP. !	A 5Hf-5@GNP. !	K 9< <H ' "' - ?[
¥ BC H9. H]gXfuk]b['jgH'Y d'fcdYfmcZF\]bc DfcXi Wrg@X'UbX'a i ghbchVY i g'X'cfWc'd]YX'k]h'ci hk f]hYb'Wc'bg'bh'H'Y'F\]bc DfcXi WrgbUa Y'UbX'c[c'a i ghfYa U]b'WYUfmg]g]Y']b'UbmYdfcXi W]cb"		

Hk-f8 5B: @DFC >97 HC B	
I B@9GC H: 9FK @9 CD97 = 98.	
8-A 9BGC BG5F9-B'A A	
\$\$\$ ±\$& \$\$\$ ±\$" 5B; ±\$)"°	
89f J 98 8 A 9BGC BGG-C K B 'B 6F57?9G	
896I FF'5B8'6F95? 5@G< 5FD'98: 9G	
G< 99HG A9 5'	G< 99HG 7 5 @9. ' & +



A G&\$%l (



A G%, 'l (



DG&' 'l &

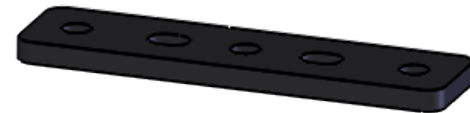

DG % 'l &

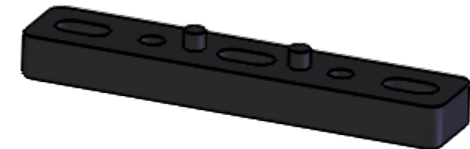

&- &\$%%% 'l &

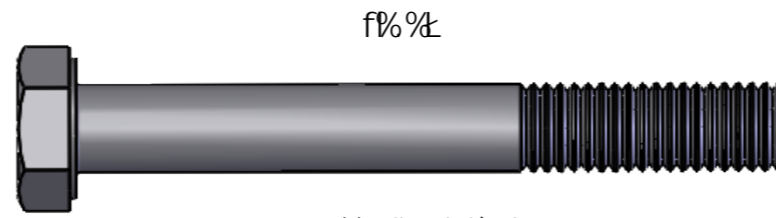

f%>%Ł

: 6\$\$' fA , 'l '*)Łl ,

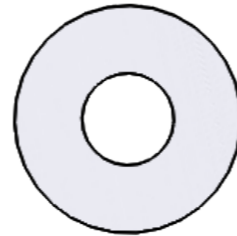

: K \$\$&fA , Łl &\$



: B \$\$* fA , Łl %&



DG&\$, 'fA , Łl (

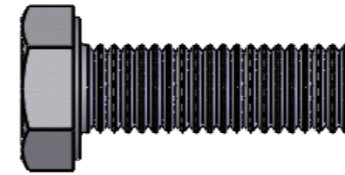

: G\$%) 'fA , 'l &)Łl &

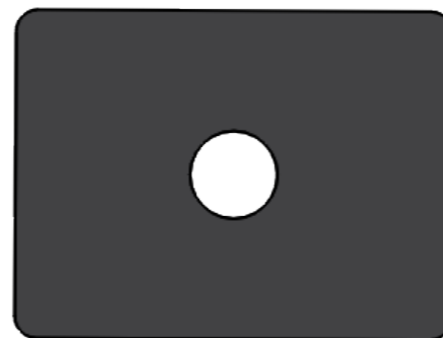

DG&\$&'l (

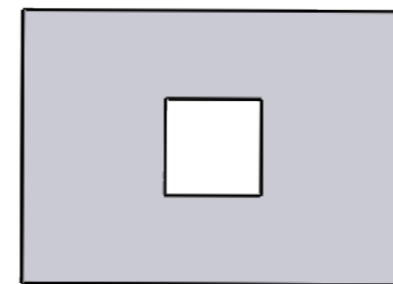

A G&\$- 'l (



: G\$') fA , 'l (\$Łl &

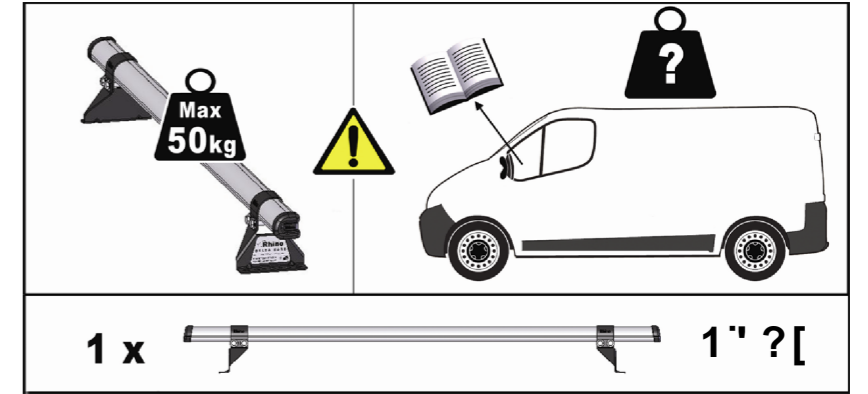

l &



% a a l &

